

Dongguan Huayu Automation Technology Co., Ltd.

东莞市华佑自动化科技有限公司

Dongguan ONCE Machinery Manufacturing Co, Ltd.

东莞市安色机械制造有限公司



安色机械[®]

ONCE

选安色, 更出色
CHOOSE ONCE, TRUST FOREVER

Introduction

Welcome to HYOO Automation and ONCE Machinery

Dongguan Huayu Automation Technology Co., Ltd. is a professional manufacturer of automation equipment. Its products include screen printing machine, pad printing machine, hot stamping machine and related equipment, which can meet the printing requirements of various shapes and materials, Widely used in daily necessities, food, cosmetics, medical supplies, auto parts and other fields and industries. Our equipment are exported to Europe, the United States, South Korea, the Middle East, South Africa, Mexico and other countries and regions, deeply trusted by customers at domestic and abroad.

ONCE Machinery Manufacturing Co, Ltd provides edge technology of Smart Engineering, Machinery, and Manufacturing on the production of automatic screen printing machines.



CATALOGUE

1

Who is Dongguan Huayu Automation Technology Co., Ltd.

2

Why Choose Huayu Automation Technology Co., Ltd.

3

What do Huayu Automation and ONCE Machinery Produce

4

Who will be Huayu Automation Valuable Customers

5

What are Huayu Automation Equipment Applications

6

What are Huayu Automation Exhibitions and Social Networks





Who is Dongguan Huayu
Automation Technology Co., Ltd.

--- ONCE Print, Forever Elegant.

About us

Dongguan Huayu Automation Technology Co., Ltd. is a professional manufacturer of automation equipment. Its products include screen printing machine, pad printing machine, hot stamping machine and related equipment, which can meet the printing requirements of various shapes and materials, Widely used in daily necessities, food, cosmetics, medical supplies, auto parts and other fields and industries. Our equipment are exported to Europe, the United States, South Korea, the Middle East, South Africa, Mexico and other countries and regions, deeply trusted by customers at domestic and abroad.

ONCE Machinery Manufacturing Co, Ltd provides edge technology of Smart Engineering, Machinery, and Manufacturing on the production of automatic screen printing machines.



Organization Chart

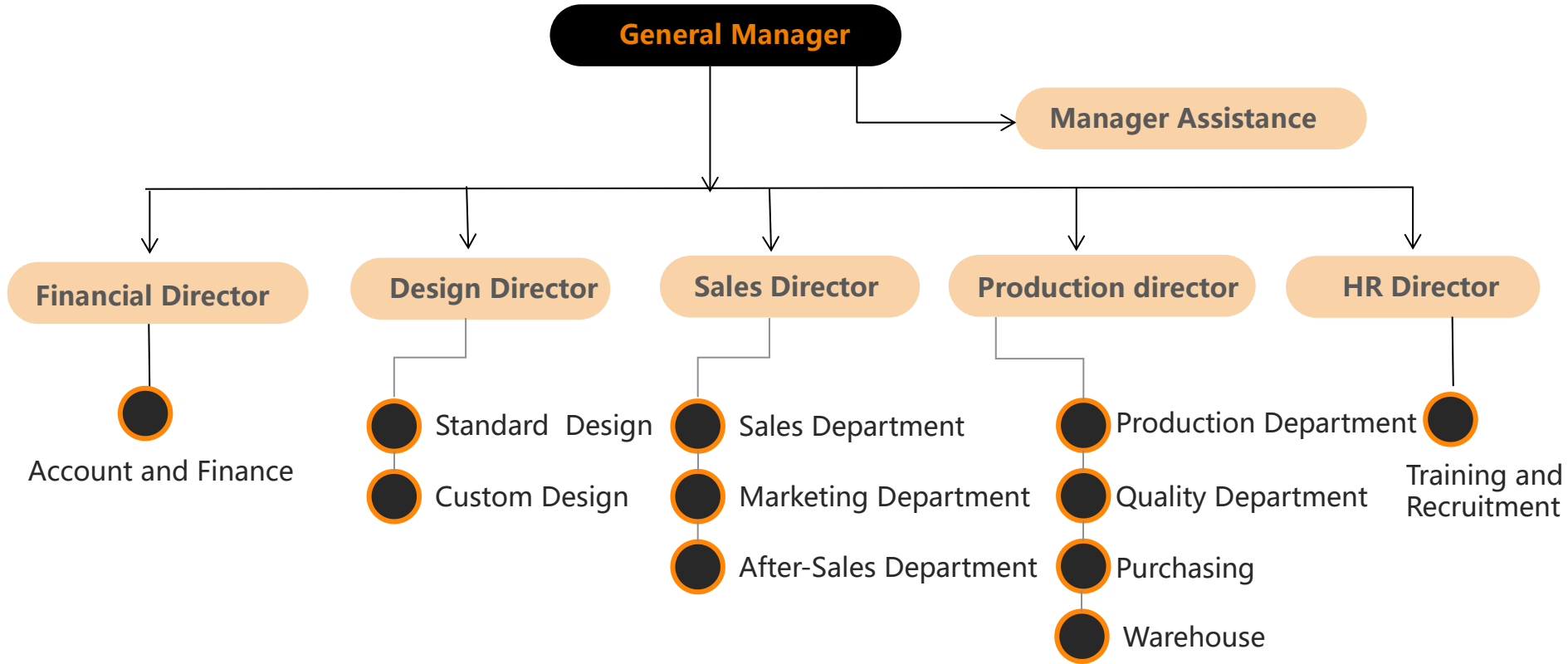

Factory Overview



Standard Machine Assembly



Customized Machine Assembly



Semi-products Processing Zone



Pending Area



Finished Machine Warehouse



Raw Material Warehouse



Sample Checking and Testing



Electrical Equipment Zone

Workshop Overview



CNC Machining Zone



CNC Machining Zone



Custom Machine Zone



Standard Machine Zone

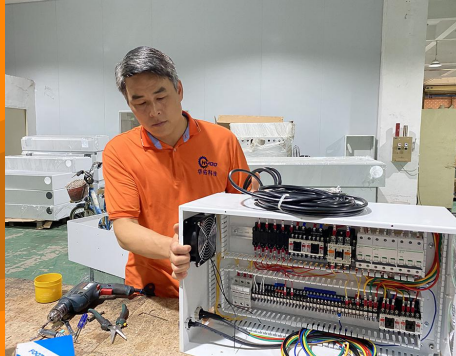

Electrical Equipment Zone



Assembly Zone



Adjusting Zone



Adjusting Zone

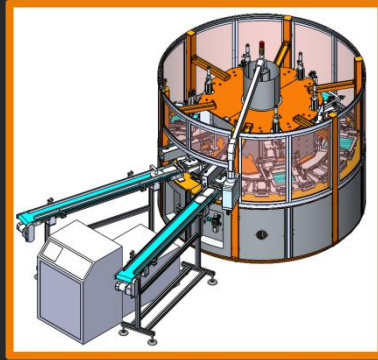

Why Choose Huayu Automation Technology Co., Ltd.

--- Automatic Round Screen Printing Machine Manufacturer

Business Registration

编号: N° 0733473



营业执照

(副本) (副本号:1-1)

统一社会信用代码 91441900056795850P

名称	东莞市安色机械制造有限公司
类型	有限责任公司(自然人投资或控股)
住所	东莞市常平镇桥梓村桥梓大道首长科技工业园C栋一楼中
法定代表人	张华
注册资本	人民币壹佰万元
成立日期	2013年11月07日
营业期限	长期
经营范围	产销、制造:通用机械设备、包装机械、塑胶专用机械设备。 (依法须经批准的项目,经相关部门批准后方可开展经营活动。)



登记机关  2016年8月1日

企业信用信息公示系统网址: <http://gsxt.gd.gov.cn/> 中华人民共和国国家工商行政管理总局监制



营业执照

统一社会信用代码 91441900MA4W0Y3PX9



扫描二维码登录“国家企业信用信息公示系统”了解更多登记、备案、许可、监管信息。

名称	东莞市华佑自动化科技有限公司	注册资本	人民币伍佰万元
类型	有限责任公司(自然人投资或控股)	成立日期	2016年11月28日
法定代表人	张华	营业期限	长期
经营范围	研发、产销:自动化机械设备、机电设备、包装机械、印刷机、塑胶专用机械设备;货物进出口、技术进出口。(依法须经批准的项目,经相关部门批准后方可开展经营活动。)	住所	广东省东莞市常平镇常横路144号1栋102室

登记机关  2019年11月28日

请于每年6月30日前报送年度报告,逾期将受到信用惩戒和处罚。
途径:登录企业信用信息公示系统,或“东莞市场监管”微信公众号。

国家企业信用信息公示系统网址: <http://www.gsxt.gov.cn> 国家市场监督管理总局监制

ONCE Business Registration

Huayu Business Registration

Certifications and Patents

EST Standard Testing & Certification



Certificate of Conformity

According to Machinery Directive 2006/42/EC
Certificate No.: ESTSZ141003227M

Applicant	: Once Machinery Manufacturing Co., LTD Building C, Shouzhong S&T Zone, Gaozui Avenue Changping, Dongguan City, Guangdong Province
Manufacturer	: Once Machinery Manufacturing Co., LTD Building C, Shouzhong S&T Zone, Gaozui Avenue Changping, Dongguan City, Guangdong Province
Trade Mark	: N/A
Product	: Printing Machine
Model No.	: OS-175, OS-230, OS-400, OS-416, OS-616, OS-767, OS-767XL, OS-F12, OS-R320T, OS-R45
Test Report No.	: ESTSZ141003227M
Test Standard(s)	: 2006/42/EC Annex I EN ISO 12100: 2010 EN 60204-1:2006+A1: 2009

The certificate of conformity is based on an evaluation of a sample of the above mentioned product. Technical report and documentation are at the applicant's disposal. This is to certify that the tested sample is in conformity with all revision of Annex I of Council Directive 2006/42/EC, in its latest amended version, referred to the Machinery Directive. The certificate does not imply assessment of the series-production of the product and does not permit the use of EST logo. The applicant of the certificate is authorized to use this certificate in connection with EC declaration of conformity to Annex II of the Directive.

 Javier Cobin
 For Chief Executive
 Date of Issue: Nov. 07, 2014





The CE Marking may only be used if all relevant and effective EC Directives are complied with.

SHENZHEN EXACT STANDARD TESTING TECHNOLOGY CO., LTD.
No.403, Building 7, Ninyuan Industrial Park, Xingqiang Road, Xili, Nanshan District, Shenzhen, Guangdong, China
Tel: (86)755-26548610 Fax: (86)755-26548927 http://www.estcd.com

Page 1 of 1

证书号 第9440176号

实用新型专利证书

实用新型名称: 一种具有表干装置的立式转盘丝印机

发明人: 张华

专利号: ZL 2018 2 2103957.5

专利申请日: 2018年12月14日

专利权人: 东莞市安色机械制造有限公司

地址: 523000 广东省东莞市常平镇桥梓村桥梓大道首长科技工业园C栋一楼中

授权公告日: 2019年10月01日 授权公告号: CN 209454343 U

国家知识产权局依照中华人民共和国专利法经过初步审查, 决定授予专利权, 颁发实用新型专利证书并在专利登记簿上予以登记。专利权自授权公告之日起生效。专利期限为十年, 自申请日起算。

专利证书记载专利权登记时的法律状况。专利权的转移、质押、无效、终止、恢复和专利权利人的姓名或名称、国籍、地址变更等事项记载在专利登记簿上。

 局长 申长雨
 申长雨





2019年10月01日

第 1 页 (共 2 页)

其他事项参见背面

证书号 第10383499号

实用新型专利证书

实用新型名称: 可快速二次印刷的UV丝印机

发明人: 张华

专利号: ZL 2019 2 1046363.3

专利申请日: 2019年07月06日

专利权人: 东莞市安色机械制造有限公司

地址: 523000 广东省东莞市常平镇桥梓村桥梓大道首长科技工业园C栋一楼中

授权公告日: 2020年04月24日 授权公告号: CN 210390444 U

国家知识产权局依照中华人民共和国专利法经过初步审查, 决定授予专利权, 颁发实用新型专利证书并在专利登记簿上予以登记。专利权自授权公告之日起生效。专利期限为十年, 自申请日起算。

专利证书记载专利权登记时的法律状况。专利权的转移、质押、无效、终止、恢复和专利权利人的姓名或名称、国籍、地址变更等事项记载在专利登记簿上。

 局长 申长雨
 申长雨



2020年04月24日

第 1 页 (共 2 页)

其他事项参见背面

CE
Approval

Products
Patents

Products
Patents

Advantages and Strengths

1 **Cost advantages**
Cost down the raw material from the from the first process to the final, but do not narrow the quality.

2 **Technology highlights**
We not only can produce standard printing machines, but also customized machines are available on request.

3 **Professional marketing and selling strategies**
Fast lead time & stock, Strong sales support, Sales response quickly, Exhibitions overseas

4 **Perfect after-sales service**
Professional manufacturer, High quality commitment, Strong technical support, Excellent customer service



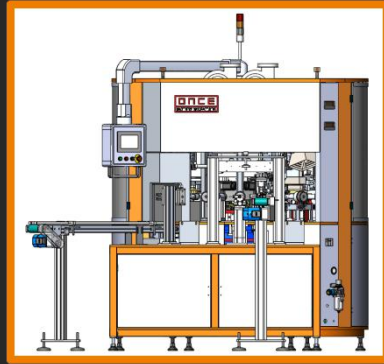
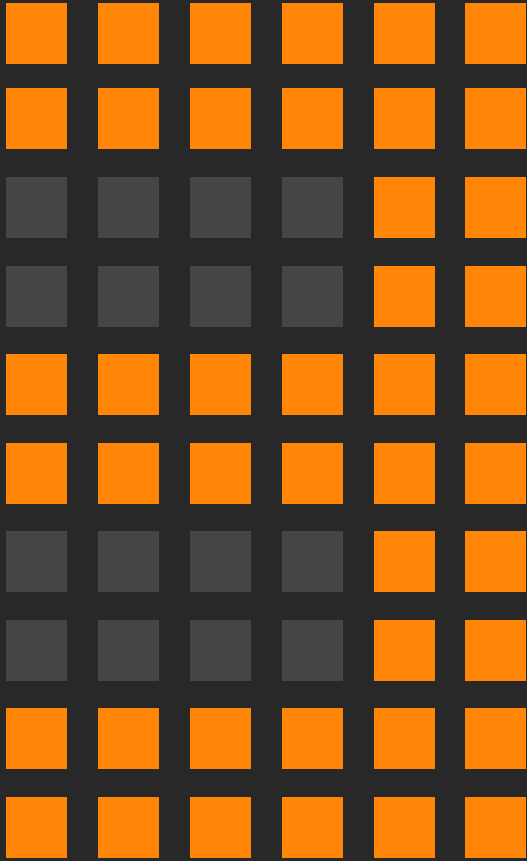

What do Huayu Automation and ONCE Machinery Produce

--- Printing Machines - Robust, Reliable, Scalable, Easy-To-Use

Full Range of Printing Machines (Screen Printing)

Cylindrical Printing Machine

Round container size:	Diameter: ϕ 10-100mm, Height: 30-260mm
Round container max. print area:	L 260 x W220mm
Oval container size:	R: 10-250mm, Height: 30-260mm
Oval container max. print area:	L 120 x W220mm

Flat Printing Machine

Print product size:	L160 x W160 x H100 mm
Flat container max. print area:	L110 x W90 mm
Stations:	24 stations
Max. printing speed:	45 pcs/min

Bucket Printing Machine

Bucket size:	Diameter: ϕ 150-350mm, Height: 200-400mm
Max. print area:	L900 x W250mm
Flame treating system:	3 units, LP gas
Max. printing speed:	25 pcs/min

Tubes Printing Machine

Print product size:	ϕ 10mm- ϕ 75mm, L: 20mm-230mm
Max. print area:	236x170mm
Stations:	12 stations
Max. printing speed:	60-80 pcs/min

We provides edge technology of Smart Engineering, Machinery, and Manufacturing on the production of automatic screen printing machines.

Product List



OS-767-1: One Color Automatic UV Silk Screen Cylindrical Printing Machine

OS-767-2: Two Color Automatic UV Bottle Silk Screen Printing Machine

OS-767-3: Three Color Automatic Round Bottle Silk Screen Printing Machine

OS-767-6: Five Color Automatic Round Bottle Silk Screen Printing and Hot Stamping Machine

OS-175: One Color Automatic Cosmetic Tube Screen Printing Machine

OS-230: Two Color Automatic Cosmetic Tube Screen Printing Machine

OS-320: One to Six Color Automatic Soft Tube Rotary Table UV Screen Printing Machine

OS-R324: Three Color Automatic Flat Bed Screen Printing Machine Printer

OS-T106: One Color Automatic Hot Stamping Machine Printer

OS-1000: One to Eight Color Automatic Bucket UV Screen Printing Machine

Star products

OS-767

1 to 6 color automatic UV bottle screen printing machine
Fast print speeds up to 4200 bottles per hour
Accurate color to color registration
Prints on round, oval and square bottles.



Standard Strong Products

OS-175



One Color Automatic Cosmetic Tube Screen Printing Machine

OS-230



Two Color Automatic Cosmetic Tube Screen Printing Machine

Standard Strong Products

OS-324



Three Color Automatic Flat Bed Screen Printing Machine Printer

OS-320



One to Six Color Automatic Soft Tube Rotary Table UV Screen Printing Machine

Standard Strong Products

OS-1000



One to Eight Color Automatic Bucket UV Screen Printing Machine

OS-T106



One Color Automatic Hot Stamping Machine Printer

Standard Strong Products

OS-324



Three Color Automatic Flat Bed Screen Printing Machine Printer

OS-767



Automatic Screen Printing Machine and Labeling Machine

Standard Strong Products

OS-340



Automatic Screen Printing Machine for Pressure Tank Products



Automatic Screen Printing Machine Discharging For 15ml 50ml Polypropylene Centrifuge Medical Tubes

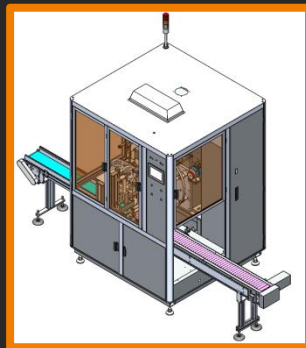

Who will be Huayu Automation Valuable Customers

--- Choose ONCE, trust forever

Customer Country Distribution



45%

20 Years Manufacturing in Printing Machines

Guangdong, Hubei, Henan, Anhui, Shanghai, Shandong, Jiangsu, Zhejiang, Jiangxi and other cities. We also have distributors in these regions.

55%

8 Years Exporting Experience Worldwide

Our equipment are exported to Europe, the United States, South Korea, Japan and the Middle East, South Africa, Mexico and other countries.

Customer Industry Distribution

40%

Cosmetic and Personal Care Industry

Eyebrow pencil, lipstick, penholder, eyelash brush, shower gel bottle, shampoo bottle, face cream bottle and other round and flat bottles.

30%

Food and Drinking Industry

Water cup, milk bottle, coffee cup, tea jar, biscuit jar, thermos cup and other Cylindrical and oval containers

20%

Pharmaceutical Industry

Dial gauge container, PP test tube, disposable syringe, insertion tube and other tube containers

10%

Chemical and Auto Industry

Plastic bottle, oil bottle, oil filter, Paint bucket, paint bucket, glass hose and other round products

Typical Brand Cases

AVON
雅芳

CARSLAN

BOSS
HUGO BOSS

CLINIQUE
倩碧

LANCÔME
PARIS
兰蔻

BIOHERM
碧欧泉

ESTÉE
LAUDER
COMPANIES

MARY KAY®
玫琳凯

Dior
迪奥

TJOY
丁家宜

Johnson's baby
强生

MAYBELLINE
美宝莲

MAC
魅可

OLAY
玉兰油

~H₂O+

apple

Calvin Klein

L'ORÉAL®

MAHLE

DELPHI

NISSAN

相宜本草
INOHERB

LOCK & LOCK

P&G

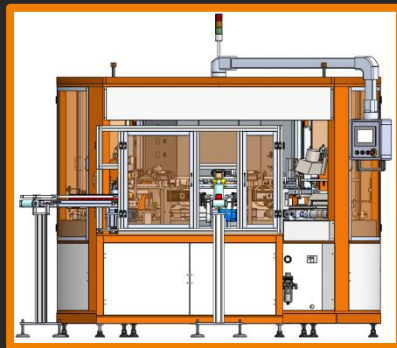

What are Huayu Automation Equipment Applications

--- We are here to create the best printing solutions for your business.

Application in Shapes



Bottle – Round



Bottle – Flat - One Side



Bottle – Flat - Front and Back



Bottle – Oval - Front and/or Back



Bottle – 3-Sided - One Label



Bottle – 4-Sided - One Label



Product – Top Only



Product – Bottom - With/Without Top



Carton, Small Box



Case, Carton, Corner Labeling



Round, Tapered



Vial, Syringe



Special Applications

Application in Functions



Water Bottles



Wine Glass Bottles



Personal Care



Bucket / Pail



Pharmaceutical



Auto / Oil Bottles



Chemicals



Beauty Care



Cosmetics Bottles



Cosmetics Tubes

Main Applications Showcase

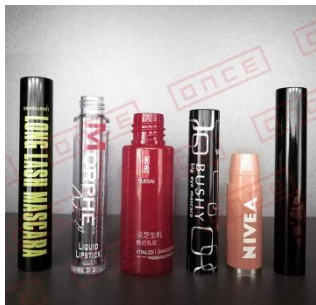

Main Applications Showcase

H400 华佑科技
 Manufacturer of Automatic Screen Printing Machines and Hot Stamping Machines



Dongguan Huayu Automation Technology Co., Ltd www.hyoauto.com, sales@hyoauto.com

H400 华佑科技
 Manufacturer of Automatic Screen Printing Machines and Hot Stamping Machines



Dongguan Huayu Automation Technology Co., Ltd www.hyoauto.com, sales@hyoauto.com

H400 华佑科技
 Manufacturer of Automatic Screen Printing Machines and Hot Stamping Machines



Dongguan Huayu Automation Technology Co., Ltd www.hyoauto.com, sales@hyoauto.com

H400 华佑科技
 Manufacturer of Automatic Screen Printing Machines and Hot Stamping Machines



Dongguan Huayu Automation Technology Co., Ltd www.hyoauto.com, sales@hyoauto.com

H400 华佑科技
 Manufacturer of Automatic Screen Printing Machines and Hot Stamping Machines



Dongguan Huayu Automation Technology Co., Ltd www.hyoauto.com, sales@hyoauto.com

H400 华佑科技
 Manufacturer of Automatic Screen Printing Machines and Hot Stamping Machines



Dongguan Huayu Automation Technology Co., Ltd www.hyoauto.com, sales@hyoauto.com

H400 华佑科技
 Manufacturer of Automatic Screen Printing Machines and Hot Stamping Machines



Dongguan Huayu Automation Technology Co., Ltd www.hyoauto.com, sales@hyoauto.com

H400 华佑科技
 Manufacturer of Automatic Screen Printing Machines and Hot Stamping Machines



Dongguan Huayu Automation Technology Co., Ltd www.hyoauto.com, sales@hyoauto.com

H400 华佑科技
 Manufacturer of Automatic Screen Printing Machines and Hot Stamping Machines



Dongguan Huayu Automation Technology Co., Ltd www.hyoauto.com, sales@hyoauto.com

H400 华佑科技
 Manufacturer of Automatic Screen Printing Machines and Hot Stamping Machines



Dongguan Huayu Automation Technology Co., Ltd www.hyoauto.com, sales@hyoauto.com

H400 华佑科技
 Manufacturer of Automatic Screen Printing Machines and Hot Stamping Machines



Dongguan Huayu Automation Technology Co., Ltd www.hyoauto.com, sales@hyoauto.com

H400 华佑科技
 Manufacturer of Automatic Screen Printing Machines and Hot Stamping Machines



Dongguan Huayu Automation Technology Co., Ltd www.hyoauto.com, sales@hyoauto.com

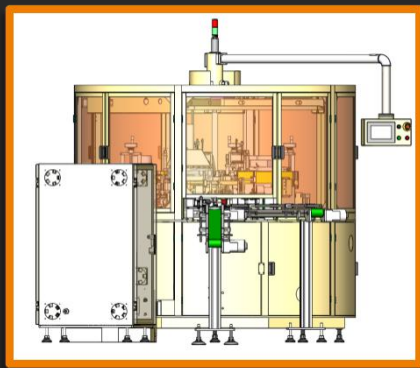

What are Huayu Automation Exhibitions and Social Networks

--- Choose ONCE, trust forever

Exhibition plan for 2015-2021

Chinaplas



Chinaplas



Chinaplas



ICMD 2019



China Beauty
Expo(CBE)



Window Door
Facade Expo



CMEF China International
Medical Equipment Fair



Chinaplas



Exhibition History Review From 2015 to 2019

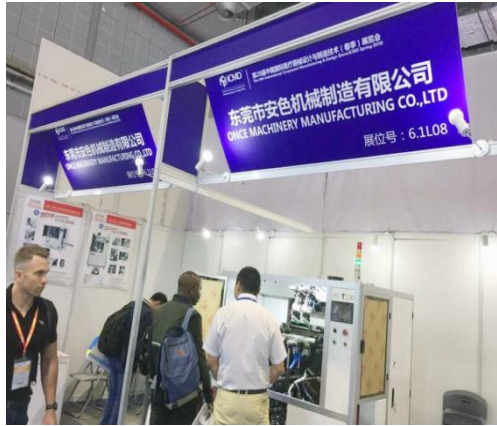
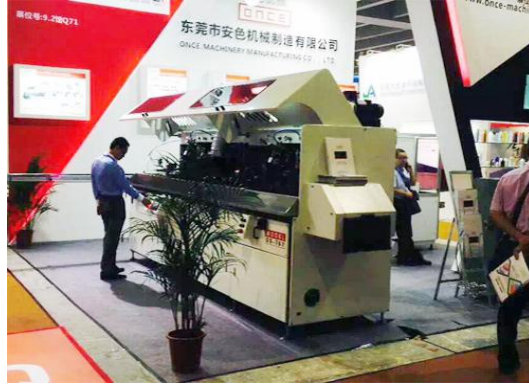

Exhibition Of China Beauty Expo(CBE) On 9th-11th July 2020 In Shanghai

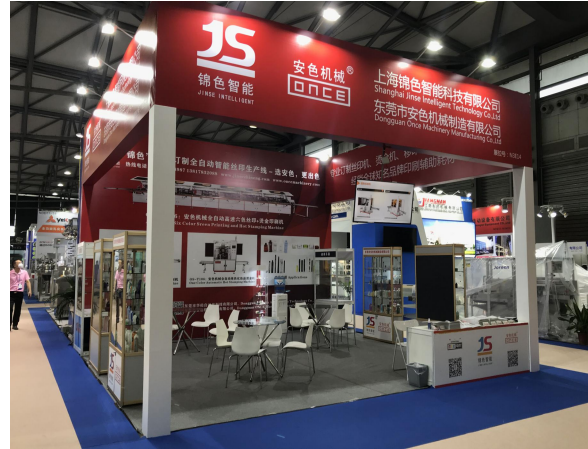
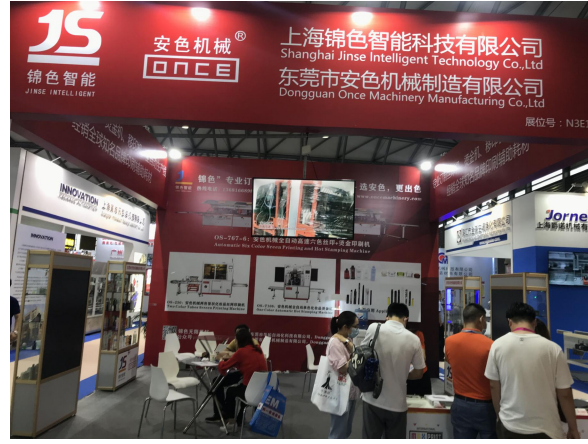

Exhibition On August 13-15, 2020 At Window Door Facade Expo In Guangzhou



CMEF China International Medical Equipment Fair On Oct 19-22, 2020

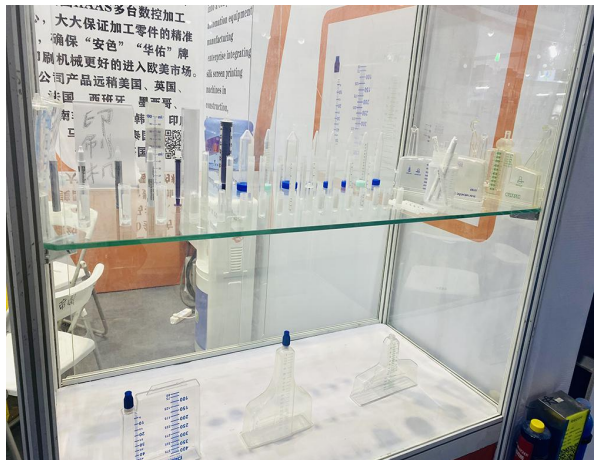

Official Website: www.hyooauto.com, www.oncemachinery.com

Company News

Company Event
Industry Activities
ONCE Exhibitions

Typical Applications

Cosmetic Bottle Printing
Water Bottle Printing
Medical Tubes Printing
Bucket Silk Printing
Glasses Screen Printing

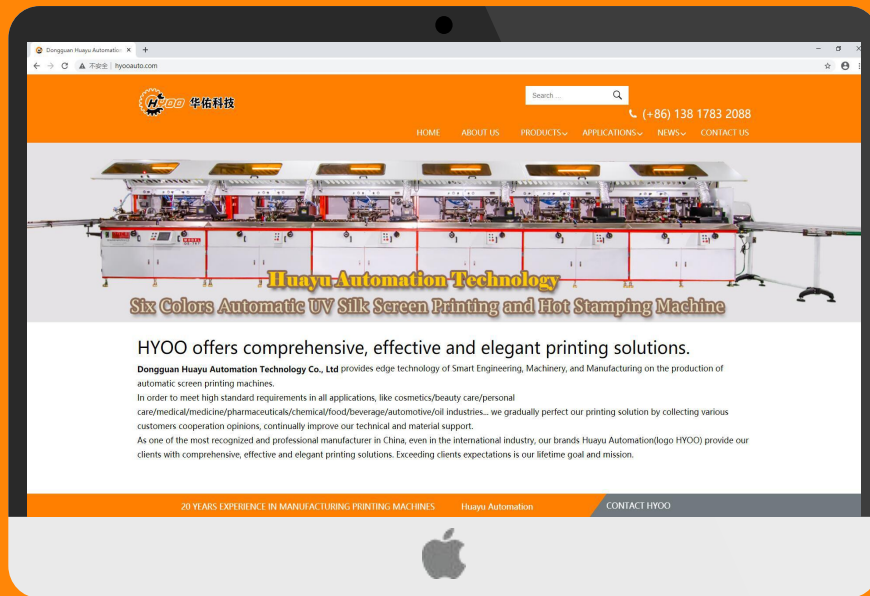

Strong Products

Cylindrical Screen Printing Machine
Bottle Screen Printing Machine
Bucket Screen Printing Machine
Flat Screen Printing Machine
Tubes Screen Printing Machine
Hot Stamping Printing Machine

选安色, 更出色
CHOOSE ONCE, TRUST FOREVER

Social Networks

Follow us, you will find a new world of Automatic Solutions

 www.hyooauto.com www.oncemachinery.com www.oncemachine.com

 www.once-machine.com www.onceprinter.com <https://oncemachinery.blogspot.com/>

 <https://www.linkedin.com/in/oncemachinery/>

 <https://twitter.com/OnceMachinery>

 <https://www.youtube.com/c/ONCEMachinery>

 <https://www.pinterest.com/oncemachinery/>

 sales@oncemachinery.com info@oncemachinery.com

Dongguan Huayu Automation Technology Co., Ltd

Dongguan ONCE Machinery Manufacturing Co., Ltd.

Address: A Building 144# - 168#, Changheng Road, Changping Town,
Dongguan City, Guangdong Province, China

Tel : (86) 0769 8298 7188

Fax : (86) 0769 8298 5899